

CHRONOFLASH 25

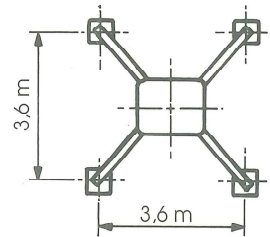
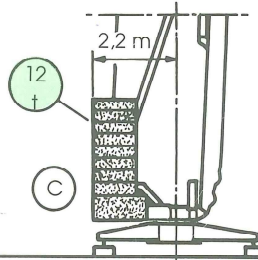
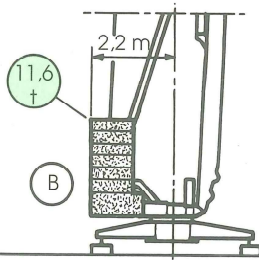
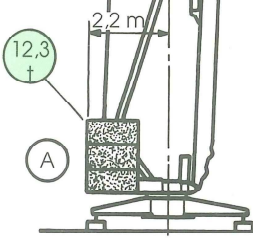
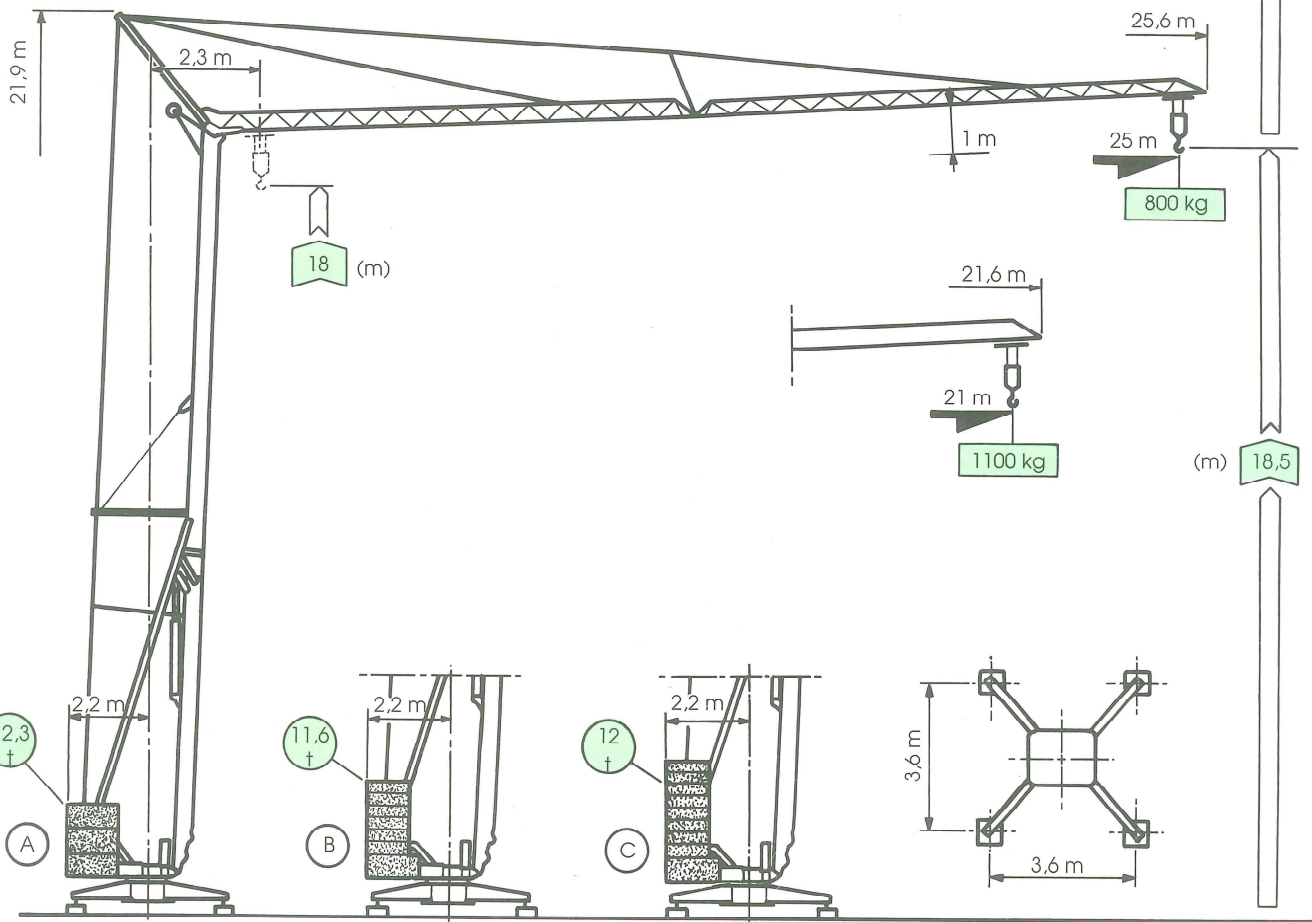
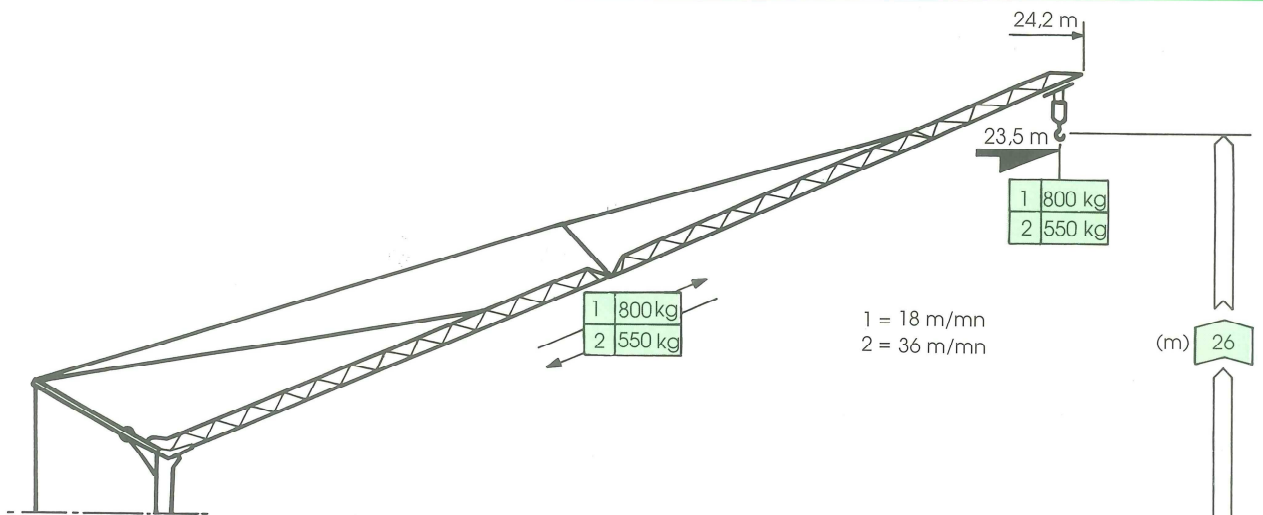

12 †
EN SERVICE
IN BETRIEB
EN SERVICIO
IN SERVIZIO

7.3 †
A VIDE SANS LEST NI TRAINS DE TRANSPORT
OHNE LAST, BALLAST UND TRANSPORTACHSE
WITHOUT LOAD, BALLAST OR TRANSPORT AXLES
VACIO, SIN LASTRE NI TREN DE TRANSPORTE
SENZA ZAVORRA NE ASSALI DI TRASPORTO

		CHONOFASH 25														
		12	12.9	13	14	15	16	17	18	19	20	21	22	23	24	25 m
	25 m	2000	1810	1790	1640	1500	1390	1290	1200	1120	1060	990	940	890	840	800
	21 m		2000	1980	1800	1660	1530	1420	1320	1240	1170	1100				kg

CHRONOFLASH 25

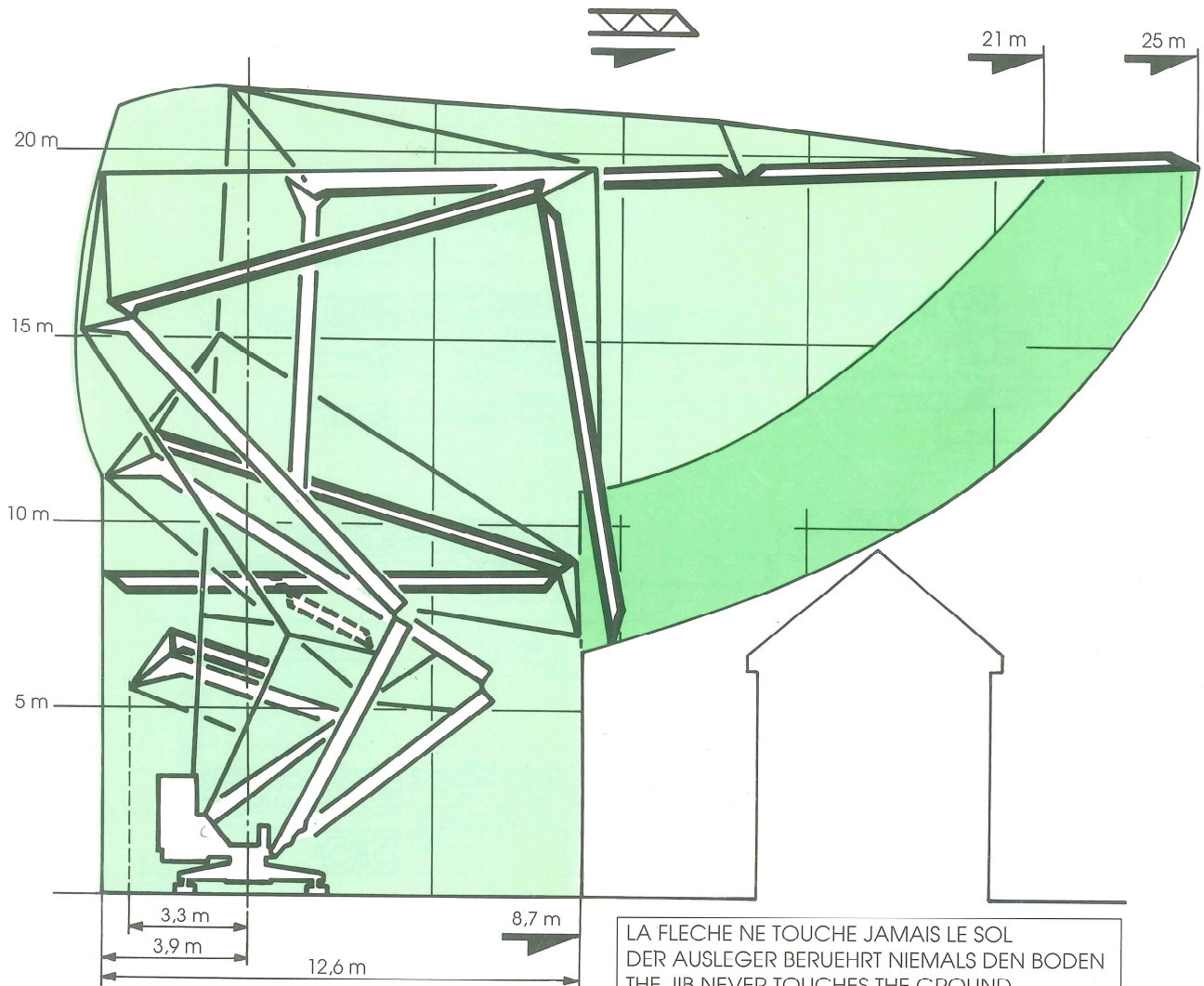

ENCOMBREMENT AU MONTAGE
SPACE REQUIREMENT
INGOMBRI DI MONTAGGIO

ABMESSUNGEN
ENCOMBRAMIENTO

LA FLECHE NE TOUCHE JAMAIS LE SOL
DER AUSLEGER BERUEHRT NIEMALS DEN BODEN
THE JIB NEVER TOUCHES THE GROUND
LA FLECHA NO TOCA NUNCA EL SUELO
IL BRACCIO NON TOCCA MAI IL SUOLO

CHRONOFLASH 25		m / mn	KW	ch PS-HP	kg
	I	6,5	2	2,7	2000
	II	20	6	8	2000
	III	40	6	8	1000
		0,3 > > 0,9	1,5	2	
		18 > > 36	1,5	2	



V	380	450
Hz	50	60
kVA	12	15

GRUPE ELECTROGENE
STROMAGGREGAT
GENERATOR SET
GRUPO ELECTROGENO
GRUPPO ELETTROGENO

V	380	450
Hz	50	60
kVA	25	30

CHRONOFLASH® 25

TRANSPORT
ROUTIER

TRANSPORT
STRASSE

TRANSPORT
ROAD

TRASPORTO
SU STRADA

TRANSPORTE
RUTA

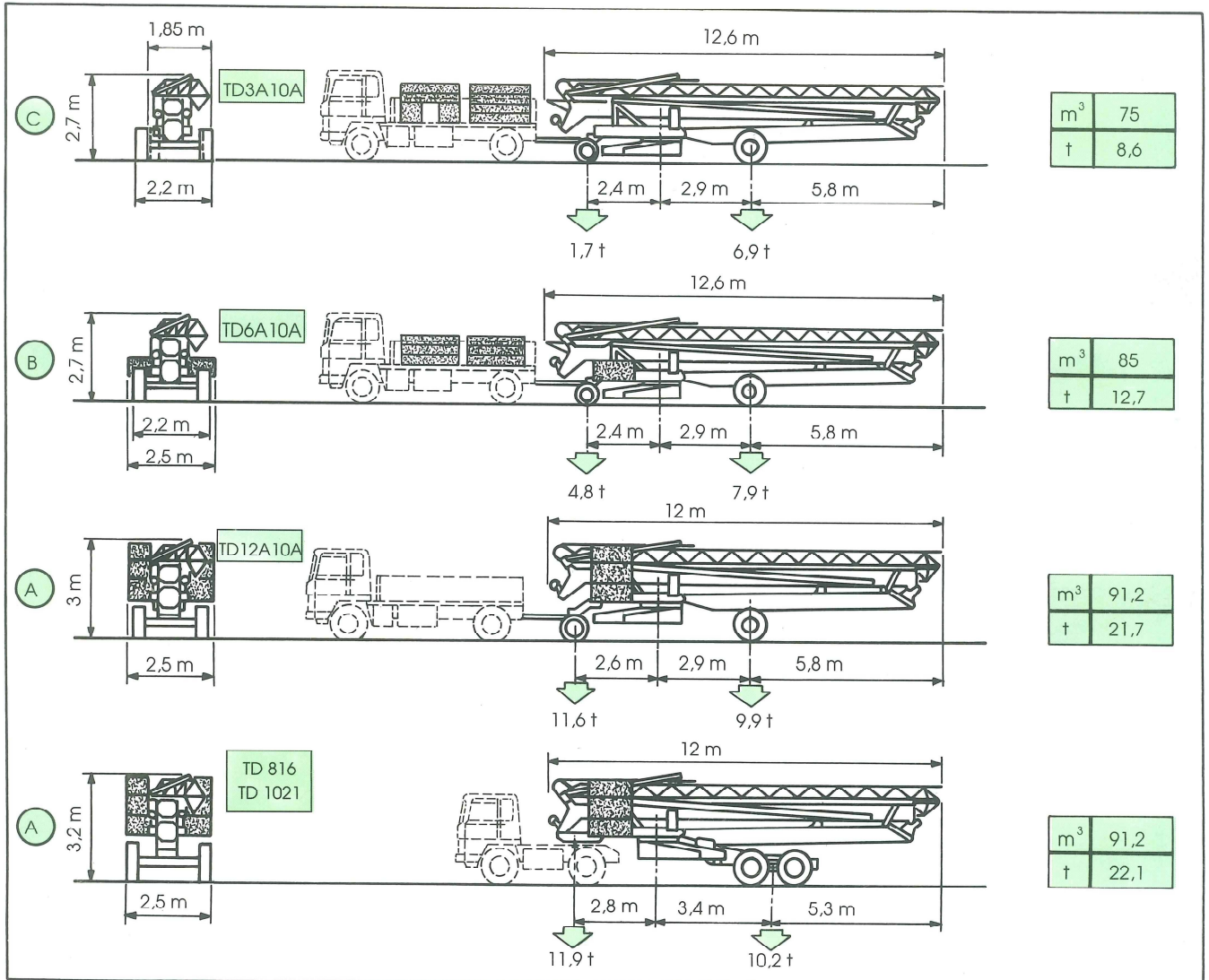

SUR
CAMION

AUF
LKW

ON
LORRY

SU
CAMION

SOBRE
CAMION

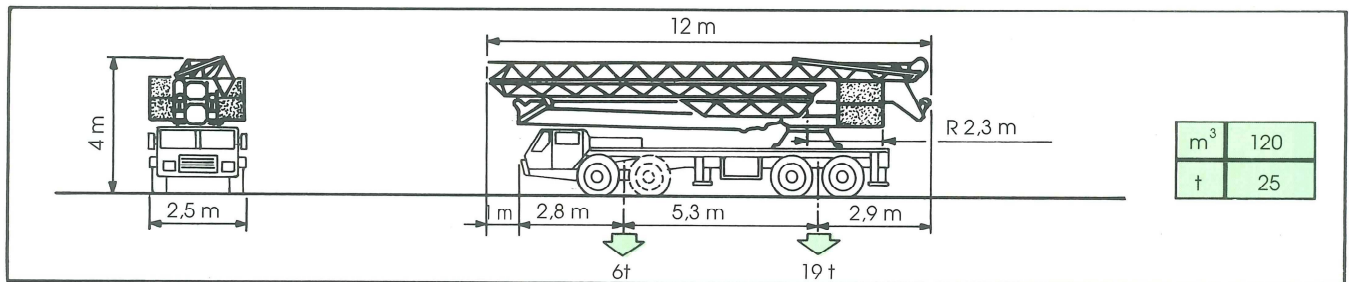

DATA N° 293.19.793

BPR-Cadillon
GRUPE LEGRIS INDUSTRIES

Siège social : 17, rue de Verdun - BP 25 - 71120 CHAROLLES - France
Tél. : 85 24 27 15 - Fax : 85 88 34 10
138, rue Julian Grimau - 94408 VITRY-SUR-SEINE Cedex - France
Tél. : (1) 45 73 39 70 - Téléc : 260 728 - Fax (1) 46 73 39 79
11, rue de la Ligne de l'Est - 69627 VILLEURBANNE Cedex -
Tél. : 72 34 99 00 - Téléc : 370 242 - Fax : 72 34 99 20
CADILLON BAUMASCHINEN G.m.b.H. : Am Dornbusch 4 - D 64331 WEITERSTADT
DEUTSCHLAND - Tél. 0 6151/98050 - Fax 0 6151/980515

WILLOH *Kranservice*